



www.jwell.cn



EXTRUSION DIES 平模头



地址: 浙江省嘉兴市海宁斜桥工业园区庆丰路128号
Tel:+86-573-87786088 (86)18851217588
Add:No.128, Qingfeng Road, Xieqiao Industrial Zone, Haining City, Zhejiang
Tel: 86-573-87786088 (86)18851217588
E-mail: sales@jwell.cn infwl@jwell.cn

邮编:314406
传真: 86-573-87787788
Postal code:314406
Fax: 86-573-87787788
Complaint E-mail: info@jwell.cn

版本号Edition No.: 2022.06

**ZHEJIANG JWELL
PRECISION MACHINERY
浙江杰伟精密机械有限公司**



A Global Supplier of Complete Solutions on Extrusion Technology

金纬机械—全球挤出技术 整体解决方案供应商

10+ 驻海外办事处 Overseas offices
580+ 技术研发&工程师 R&D Engineer
3,000+ 金纬机械员工人数 Jwell Employee
8+ 个制造基地 Manufacture Bases
500+ 独家专利技术 Patents
1,000,000m²+ 工厂面积 Plant Area



80年代初

金海螺第一代螺杆研制成功
In the early 1980s, the first generation screw of JINHAI LUO was successfully developed

1997

上海金纬机械
Shanghai JWELL Machinery

2008

苏州金纬机械
Suzhou JWELL Machinery

2012

常州金纬机械
Changzhou JWELL Machinery

2018

贝克威尔(泰国)
Bkwell (Thailand)

2019

浙江金纬智能装备
Zhejiang JWELL Machinery

2020

金纬公司业绩突破50亿人民币
Jwell's annual sales exceeded CNY 5 billion

2021

滁州金纬机械
Chuzhou JWELL Machinery

2022

连续11年荣获中国塑料机械挤出行业排名首位
Ranked first in China's plastic machinery extrusion industry for 11 consecutive years



浙江杰伟精密机械

Zhejiang Jwell Precision Machinery



浙江杰伟精密机械有限公司是专业的平模头挤出系统制造商。专业生产各种塑料片材、板材、薄膜、涂覆等各种单层或多层共挤模头，以及分配器、熔体计量泵、换网器、镜面辊筒等，我们致力于为塑料产业提供高价值的挤出成型系统；丰富的生产制造经验和持续的技术创新，配以现代化的加工设备，使产品日趋完美，广泛适用于PP、PE、PET、GPPS、HIPS、ABS、PC、PMMA、PVC、EVA、PVB等原料的生产。

公司产品已遍布全国各地，并出口到俄罗斯、印度、韩国、印尼、中东、非洲和南美洲、西班牙、意大利等100多个国家和地区，深受客户好评。

“品质卓越 完美如一”

是金纬公司的质量方针，是全体员工努力的方向。

“诚实待人”

是我们铸就“百年金纬”的核心理念。

Zhejiang Jwell Precision Machinery Co., Ltd. is a professional T-die extrusion manufacturer. Specializing in the manufacturing of different kinds for sheet, plate, film, coating single-layer and multi-layer co-extrusion die series, Various kinds of distributors, melt pumps and hydraulic screen changer, mirror roller etc, we devote ourselves work for plastic producer to provide the most value of the extrusion system; With the abundant manufacturing experience and continuously technical innovation, equipped with modern CNC processing machines, our company is making the products more perfect. Our products widely used in PP, PE, PET, GPPS, HIPS, ABS, PC, PMMA, PVC, EVA, PVB etc raw material production.

JWELL machinery has been sold across the country, and exported to all continents over the world, including the market of developed country, such as Germany, America, Japan, Spain and so on.

"Excellent Quality, Perfect All" is Jwell's quality policy, and all staff's working direction.

"Be honest" is the core idea for us to contribute "Century JWELL"

董事长: 何海潮 Email: he@jwell.cn

President: He Haichao Mobile / WhatsApp +86 13601628188

防水卷材模头系列

8米防水卷材模头

8 meters waterproof sheet coil die

PVC、EVA、PE新型防水材料具有较强的抗渗透性，有良好的防水性能，较高的耐高温、低温性能，有较好的强度及延伸率，并有优异的耐老化性特点。广泛应用于工业与民用建筑的屋面防水、建筑物地下防水、隧道防水、人工湖防水等。

特点:

- 计算机辅助歧管设计使物料分布均匀，使宽幅制品得以实现。
- 加长的模唇提高了成品取向的一致性，降低了模头膨胀，对调节的反应灵敏度大大提高。
- 在模腔中心处歧管与口模结合处所形成的曲线相贯线能够改善物料的侧向流动和分配。
- 上模唇可微调，下模唇可更换可生产不同厚度制品(1-4mm最大可做到10mm)。
- 带有节流棒调节功能，能适用不同原料、不同厚度制品的挤出。

PVC, EVA, PE new type of waterproof material have high performance of anti-permeability, water-proofness, thermo-stability and cryogenic property, high strength and elongation and have the characteristic of aging resistance, are widely used for waterproof in building roof of industry and civil construction, underground, tunnel, artificial lake, etc.

Characteristics:

- CAD of manifold making the material distributing uniformly and realize the wide products.
- The lengthening die lip improved the uniform orientation, reduced the expansion of die, highly improved the reaction of regulating.
- Line of intersection for curve formed on the joint between the center manifold of die chamber and die lip can improve the flow of side directions and distributing.
- Micro-adjustable upper die lip and changeable lower die lip for producing different thickness (1-4mm, the maximum is 10mm).
- With the function of restrictor bar adjusting and be suitable for the extrusion of different materials and thickness.



PVC Free Foamed Sheet Die

PVC自由发泡板模具

特殊衣架式流道设计，能最大限度上减少热敏性材料在挤出过程中的烧蚀。采用上模唇可调、下模唇可换及垂直节流棒调节装置，能满足不同厚度制品要求。适用生产PVC自由发泡板材，制品厚度2-20mm。

Special cloth-hanger manifold designing to relieve most ablation during material extrusion process. The up lip adjustable and bottom lip replaceable. Equipped with vertical restrictor bar adjustment and oil temperature control on the die lip to meet different thickness request for production. It is applied for thickness 2-20mm PVC foamed sheet.



PVC co-extrusion Foamed Die

PVC共挤发泡板模具

特殊衣架式流道设计，能最大限度上减少热敏性材料在挤出过程中的烧蚀。采用最新研发无节流棒、无活动模唇的设计，模口采用推拉式柔性微调。能满足不同厚度制品要求。分配器采用最新研发PVC专用共挤分配器，适用生产PVC结皮发泡板材，制品厚度5-18mm。

Special cloth-hanger manifold designing to relieve most ablation during material extrusion process. Applied with newest non-restrictor bar and without active lip designing. Die lip is applied with push-pull soft fine adjustment to meet different thickness request for production. Feed block used the newest PVC special co-extrusion model for PVC skin foamed board with thickness 5-18mm.

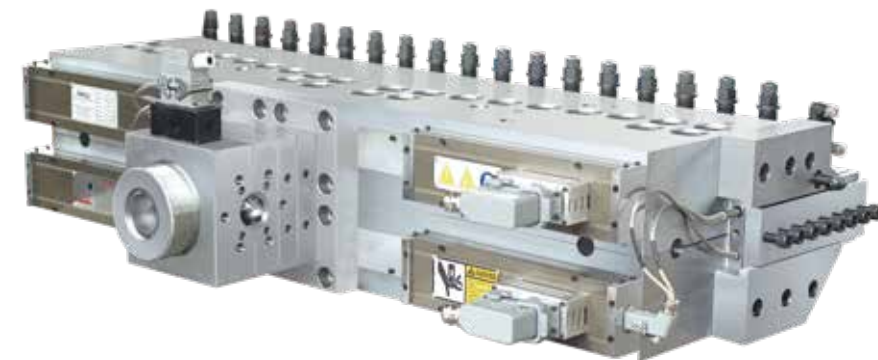

PVC Semi-skinning Foamed Board Die

PVC半结皮发泡板模具

上下模唇与本体采用一体式设计，并在模唇口配置有镶嵌式冷却口模，全流道无缝设计制作。上模唇采用最新针对PVC发泡板模头特殊设计的推位式弹性微调结构，合理的螺丝间距设计确保了调节的灵敏性，同时满足了局部可调模唇出口间隙功能，适用于生产PVC半结皮发泡板材，制品厚度3-25mm。

Up-down die lips and main body are whole body designing, whole manifold without gap designing, and tipped cooling lips equipped on exit of die. Up lip is with specially designed push-pull elastic fine adjustable structure for PVC foam board die, reasonable screw gap designing to ensure precision adjustment. At the same time meeting function of partial adjustable die lip exit gap. It is applied for thickness 3-25mm PVC semi-skinning foamed sheet.

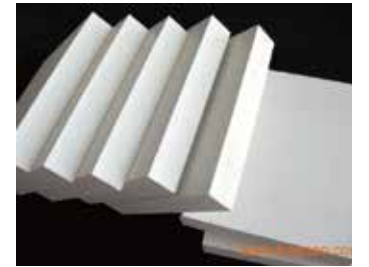

PVC Double Manifold Foamed Board Die

PVC双流道发泡板模具

采用双流道设计，上下模唇可调并带有模唇油温控制，所生产制品表面结皮效果好，内应力小，真正实现表面结皮发泡。制品厚度12-35mm。

Special cloth-hanger manifold designing to relieve most ablation during material extrusion process. The up lip adjustable and bottom lip replaceable. To meet different thickness request for production. It is applied for thickness 12-35mm PVC skin foamed sheet.

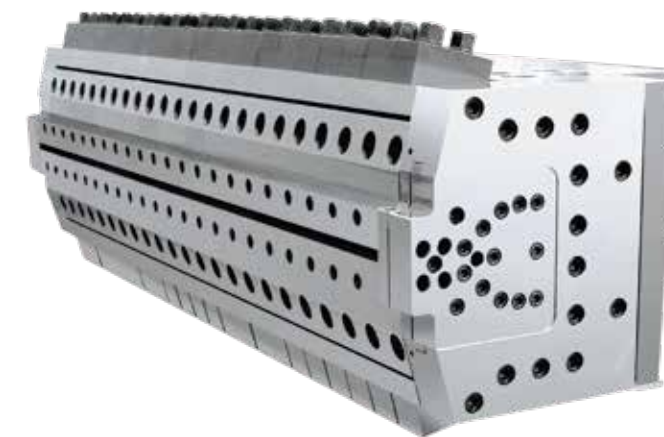

Hollow Cross Section Plate Die Series

中空格子板模具系列

PC中空阳光板广泛适用于建筑装潢、采光隔热、隔音屏障等领域。中空阳光板模具配有均匀涂覆UV层的分配器，可生产宽度为2100mm的中空制品，其耐候性、抗紫外线、耐冲性、透光率等性能极佳。模具带有上、下弹性微调模唇可调节制品壁厚误差 $\leq 3\%$ 。不同的结构设计适应各种产品要求，通用型阳光板厚度从4-25mm，多层结构板包括H型、X型等结构，厚度可达36mm以上，并可以双面涂覆抗紫外线层。

专用模具生产的PP、PE中空格子板因具有材质轻、强度高、防潮等性能适用于周转箱、灯箱广告、布展材料等方面。制品厚度范围2-12mm，宽度1200-2200mm。

PC hollow plate used widely in constructions and decorations. The hollow grid plate die and feedblock can make UV protection on both sides. The final production with a max width of 2100mm and have a high impact strength, good weather resistance and UV protection. With adjustable upper and lower mold lips, production thickness relative errors can be controlled within 3%. Different design can meet the different requirements of products, general polycarbonate hollow plate whose thickness is between 4-25mm, multi-layers plate such as H-cross section, X-cross section etc, the thickness of some can reach 36mm, and the UV layer can be coated.

The PP, PE hollow grid plate produced by special dies are light weighted, dampproof and have a high impact strength, which is widely used as advertising light panel, exhibition upholster, carry box etc. The thickness-range is 2-12mm and the width is 1200-2200mm.

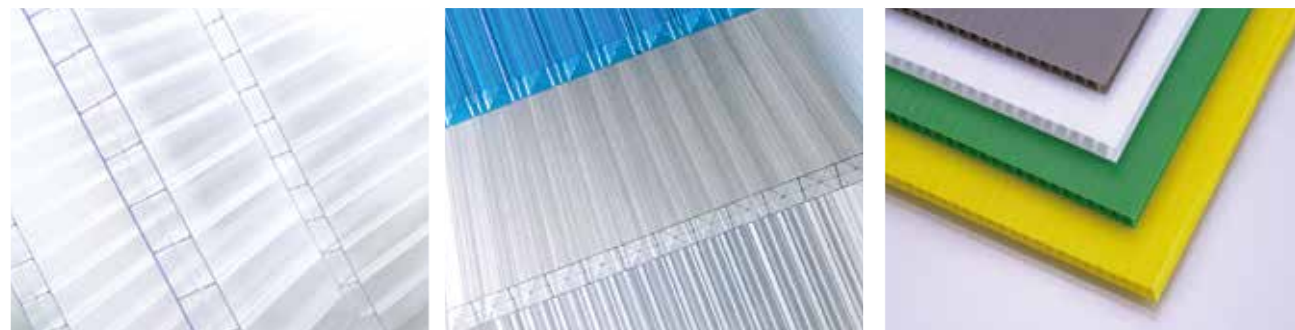

Die For Pp Hollow Sheet

PP格子板

从文具包装，农业食品装箱，展示板，到广告背板，PP中空格子板可以被广泛用于包装领域，这也意味着更多的产品种类和商业机会。PP中空格子板可以简易裁减，并丝印文字之后折叠成不同形状，杰伟模具提供客户市场上常见的四种不同结构的PP中空格子板模头，对比木质或金属类包装，PP格子板有以下优点：

From stationary packaging, Agricultural products carrier, Exhibition boards, to Advertising signs. PP Hollow Sheet can offer so much more possibilities and business opportunities. It can be easily cut to different sizes, printed with words and signs then converted to the suitable shape, compared to wood or metal packaging; PP Hollow Sheet has the advantages listed below but not limited to, JWELL can offer you the dies for 4 different market standard shapes of PP Hollow Sheet:



- 无限次可回收使用 Unlimited Reuse
- 节省存储空间 Easy Storage
- 轻便结实耐用 Light Weight But Strong and Durable
- 可用于食品级包装 Food Grade Packaging

Die For Pc Solid Sheet

PC实心板

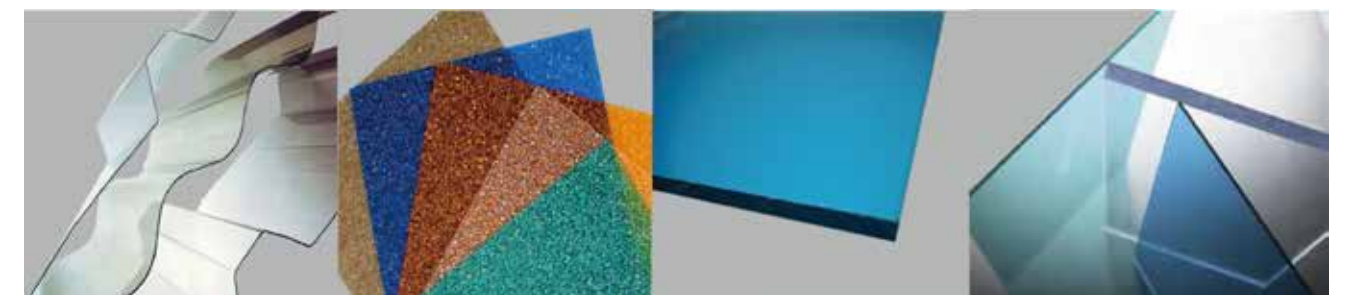

- PC 波浪板
PC Corrugated Sheet
- PC 钻石颗粒实心板
PC Embossed Sheet
- PC实心板 (可涂覆UV)
PC Solid (UV) Sheet
- PC LED扩散板
PC Diffusion Sheet
For LED Lighting

自动流延膜模头

此模头采用加长V水滴形流道,三角形分流技术以及特殊的稳流结构,有效提高各复合层的复合精度以及减少挤出过程中的‘M’形和‘W’形料流产生。上模唇采用推出式手动微调+自动微调一体式模唇,手动调节范围 $\pm 1\text{mm}$,自动调节范围 $\pm 300\mu\text{m}$;自动模唇调节控制部分我们采用的是目前非常先进的全闭环控制系统和自动测厚系统,使得产品的厚薄精度在 $\pm 2\%$ 以内,在线测厚仪在高频率不间断自动横向检测扫描,能够非常实时准确的显示制品的厚度公差。在线测厚仪检测数据经过电脑程序处理后,反馈给特殊的模唇热膨胀调节螺栓,实现对模唇的开口厚薄进行自动微调,快速有效的控制产品精度。并且我们的模头具有良好的扩展性,可以根据客户的需求选配带除厚边装置的“内堵式宽度调节装置”或“外堵式宽度调节装置”,更好的满足客户生产多种宽幅产品的可能,实现更节约、更高效的生产。

该类模头适合与生产5000mm以下,厚度在0.06-0.18mm的CPP、PE、EVA、PVC、PET、PVB、PA等单层或多层薄膜。

Auto-casting Film Die series

The die head adopts an extension V shape water-drop type flow channel,with the shunt technology and special triangle stabilize structure. To composite layer and improve the precision of the extrusion process to eliminate 'M' shape and 'W' shape flow patterns effectively. The upper die lip using push-off type manual fine-tuning + automatic fine-tuning one-piece die lip, manual adjustment range is $\pm 1\text{mm}$, automatic adjustment range $\pm 300\mu\text{m}$; About the automatic die lip adjustment control parts ,we use currently very advanced fully closed loop control system and the automatic gauging system makes the product thickness in $\pm 2\%$ precisely, on-line thickness gauge is automatic continuous detecting scanning frequently, can shows the very real-time accurate thickness tolerance of the products. Through computer program processing the data, feedback to special die lip adjusting bolt thermal expansion, and to realize the opening of the die lip thickness for automatic fine-tuning, fast and effective control product thickness precisely. And we have good die head scalability, according to customers' needs , matching with different "inside blocking type width adjusting device" or "the outer blocking type width adjusting device", be better satisfied customer's needs to more efficient production.

The die head suits for production under 5000mm,thickness between 0.06-0.18 mm CPP, PE, EVA, PVC, PET, PVB, PA, single-layer or multilayer films.

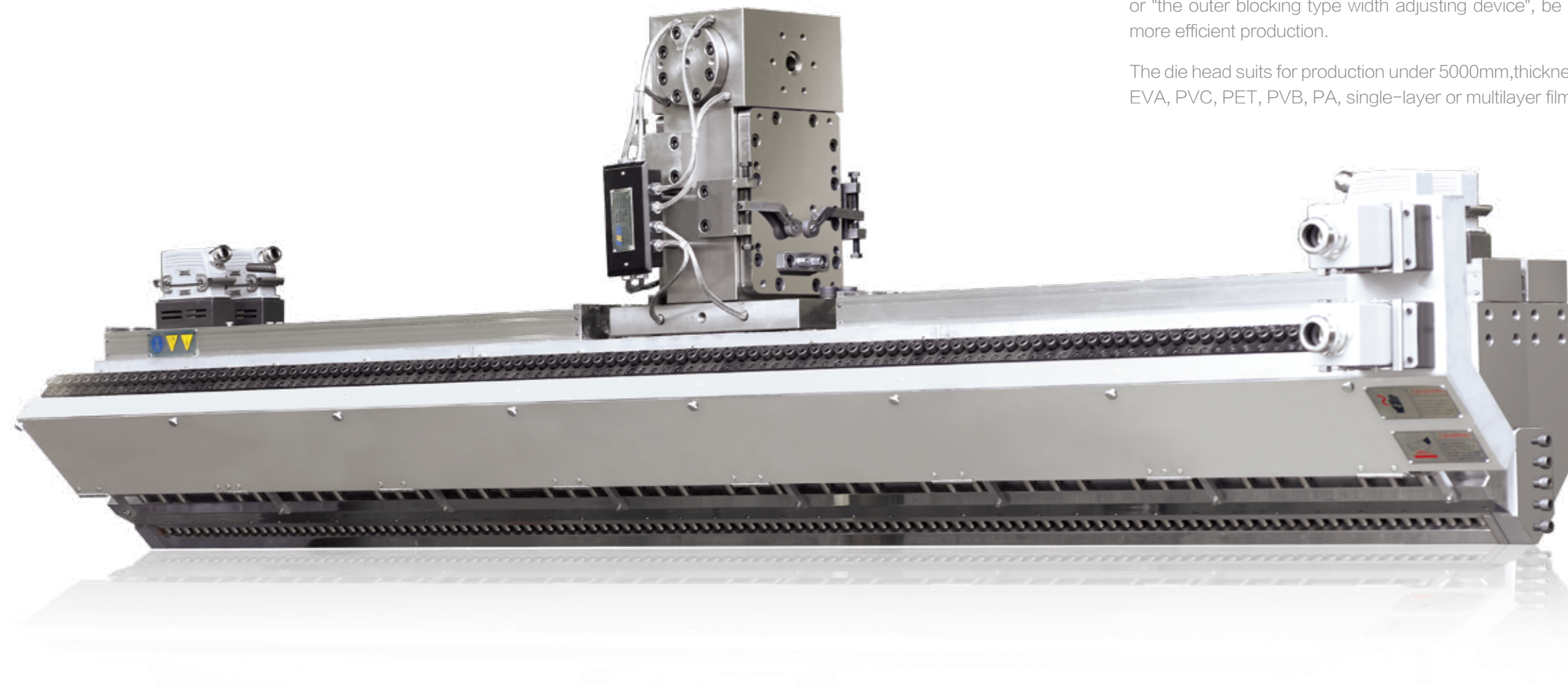

Die For U Type Lock-catch Hollow Sheet

U型锁扣板模具系列

聚碳酸酯U型锁扣板是一种先进的建筑系统，整个系统采用了可自由滑移的固定件，其具有自我紧固系统，无需在板材上钻孔，只需使用聚碳酸酯或铝制连接件即可将板材连接，从根本上解决了普通聚碳酸酯平板在不同使用温度条件下的热胀冷缩问题，直立的肋边设计使整个系统100%杜绝了安装面渗水，并能防灰尘，创新的U型锁边结构设计，使得板材安装变得更简单快捷，结合更牢固，维护更方便。被广泛用于多种采用平面或是弯曲的屋顶和覆层。

PC U Type Lock-catch Sheet is an advanced construction system. It uses free movement connecting components to link in between PC hollow sheet thus prevent shape changing during extreme weather conditions. The vertical lock-catch design ensure 100% water-proof and no dust can go inside. The convenient assembling system helps to increase installation efficiency especially for both flat and curved building roofs.

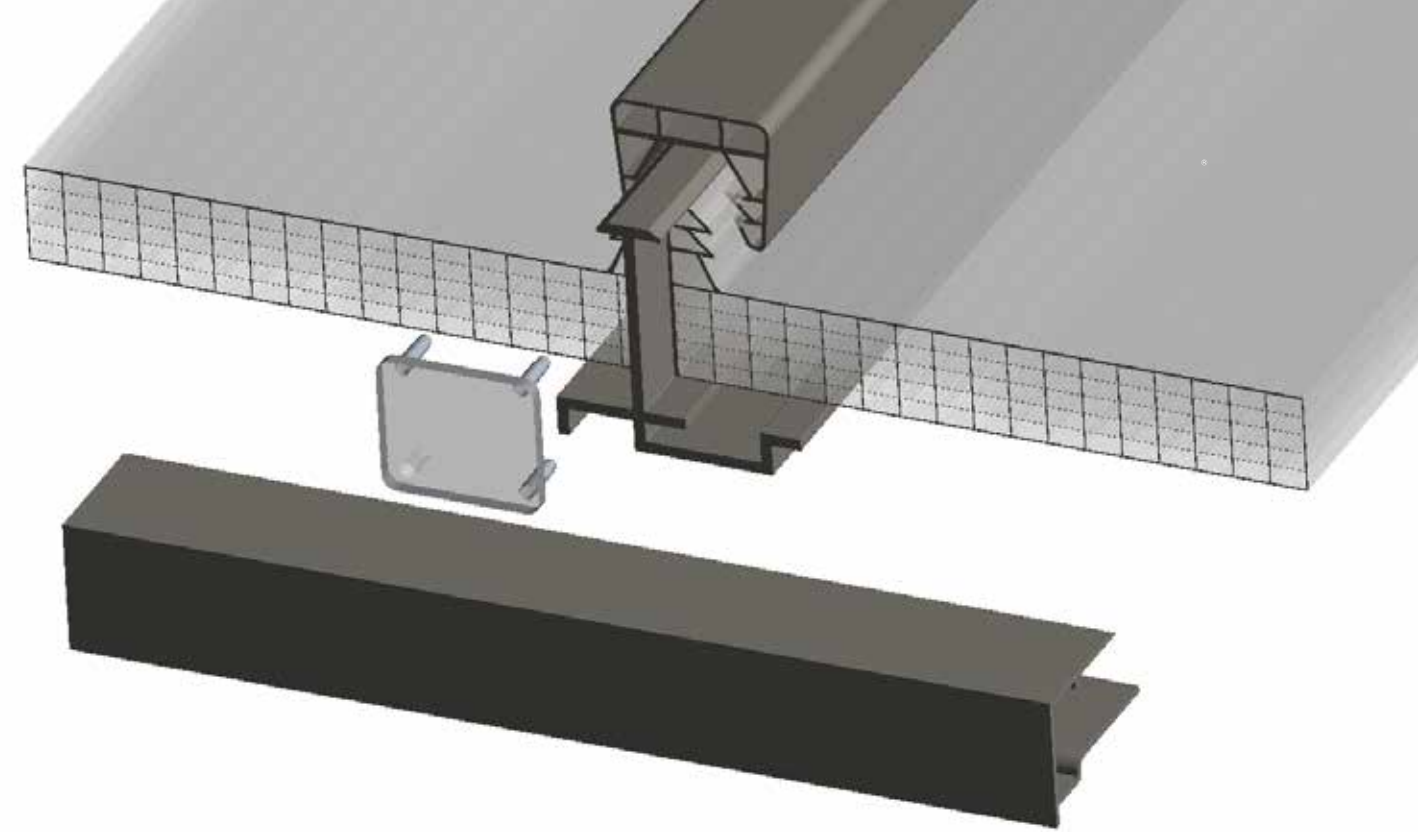
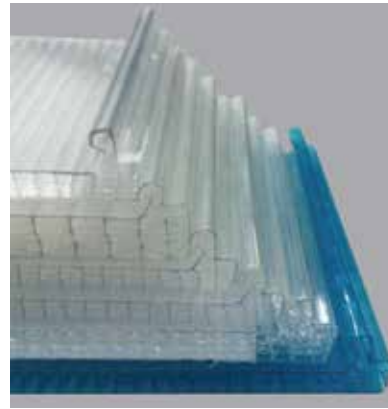

杰伟机械生产的U型中空锁扣板模具，适用于生产厚度范围4-40mm，宽度600-1050mm 规格的PC- U 型锁扣阳光板制品。采用Poly flow 三维动态熔体流变分析软件，一体式模具设计：避免多层模具组合后影响精度造成容易漏料的现象，模头容易维护，清洗，提高了使用寿命。模头内置不锈钢加热棒分区独立控制，确保配合工艺温度要求，误差在 $\pm 1^{\circ}\text{C}$ 以内。定型模采用独立分区控制的均匀抽真空装置及温度控制系统，并配有真空密封边装置，使气流在最短时间内均匀分配，快速获得更为稳定的产品。

Jwell U Type Lock-catch Hollow Die, produce sheet with thickness from 4-40mm, width between 600-1050mm. We use Polyflow software to simulates the liquid polymer flow inside the hollow dies, our unique design make sure there is no polymer leakage in different hollow layers, The Stainless steel heater used inside the die are independently controlled which allows accurate temperate adjustment can be within $\pm 1^{\circ}\text{C}$. The Calibrator is equipped with independent vacuum exhaust system and temperature control, with vacuum seal elements applied this make sure cold air-flow can be equally separated very fast hence more smooth surface of the sheet can be formed.

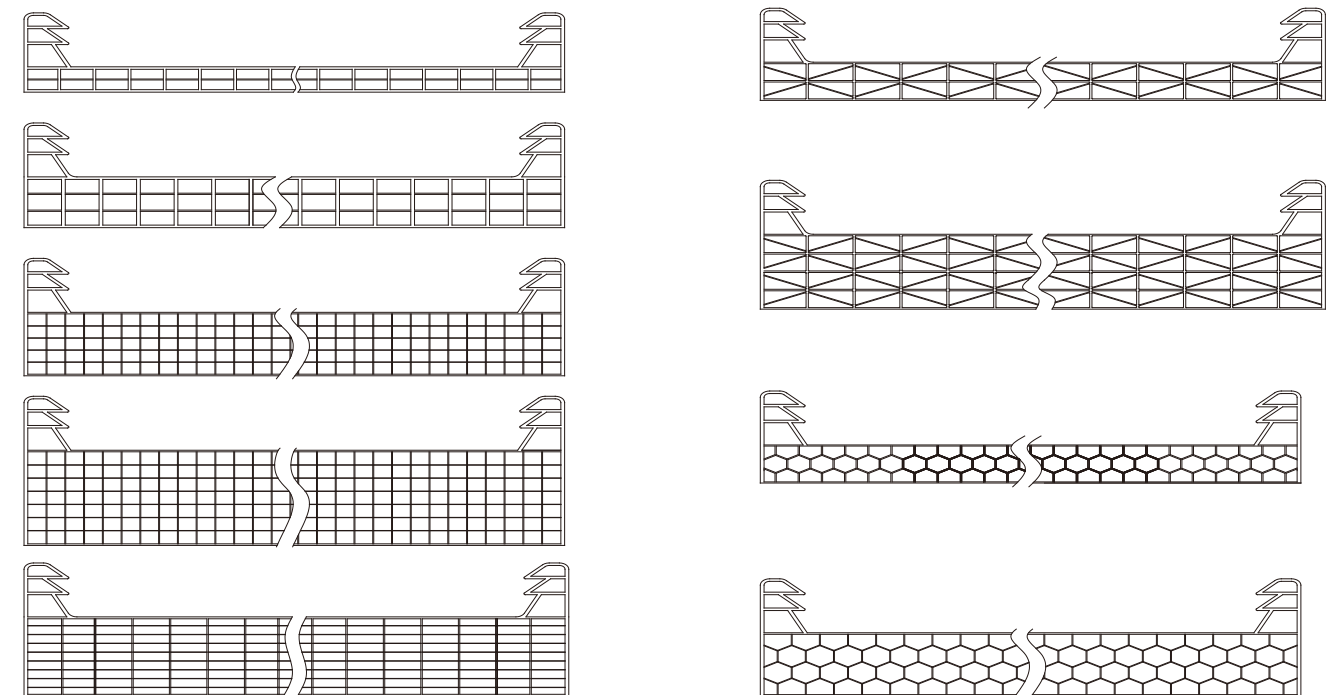

Biaxially Oriented Die

双向拉伸模头

挤出模头是双向拉伸设备中的关键部件，直接决定铸片的外形和厚度均匀性。该类双向拉伸铸片模头采用衣架型流道设计，并借助专业的计算机流体分析软件进行流道模拟分析和优化，以此获取最佳的流道参数。模唇采用推拉式自动调节模唇，可通过在线测厚仪的检测到的厚度数据经过电脑程序处理后反馈给特殊的模唇热膨胀调节螺栓，实现对模唇的开口厚薄进行自动微调，快速有效的控制产品精度；此类模头可适用于：BOPP、BOPS、BOPA、BOPET、BOPI等。

铸片模头唇口的直线度，粗糙度和唇口尖角大小直接影响产品质量，经过我们的实验与论证，模唇经过局部硬化处理后可有效改善模头质量。如表面硬度高，金相组织细化，耐磨性优于传统淬火工艺等优点，且经过硬化后的模唇能够得到更好的直线度和耐磨性。

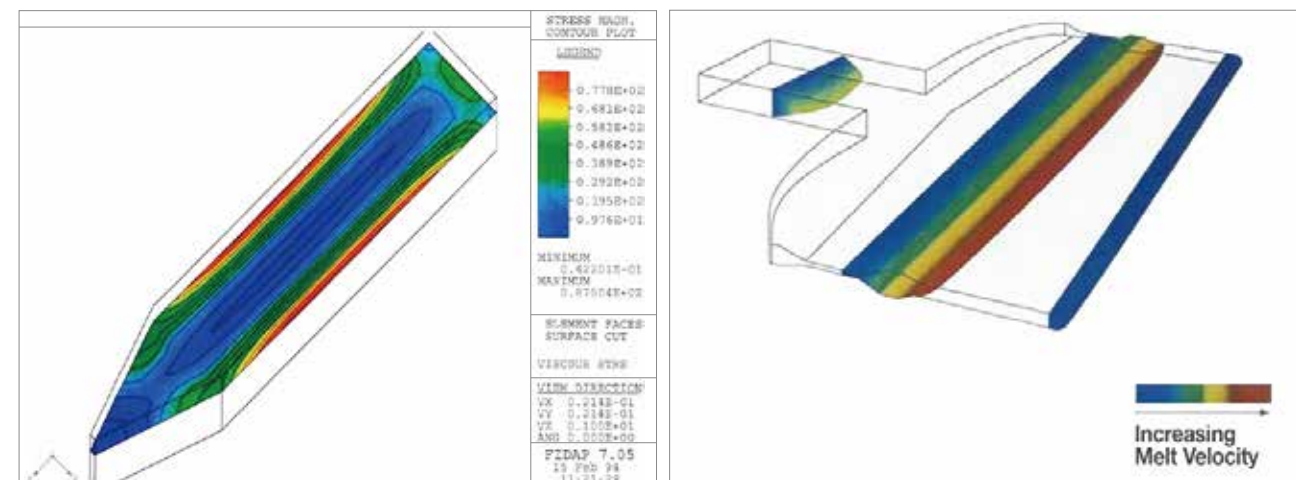
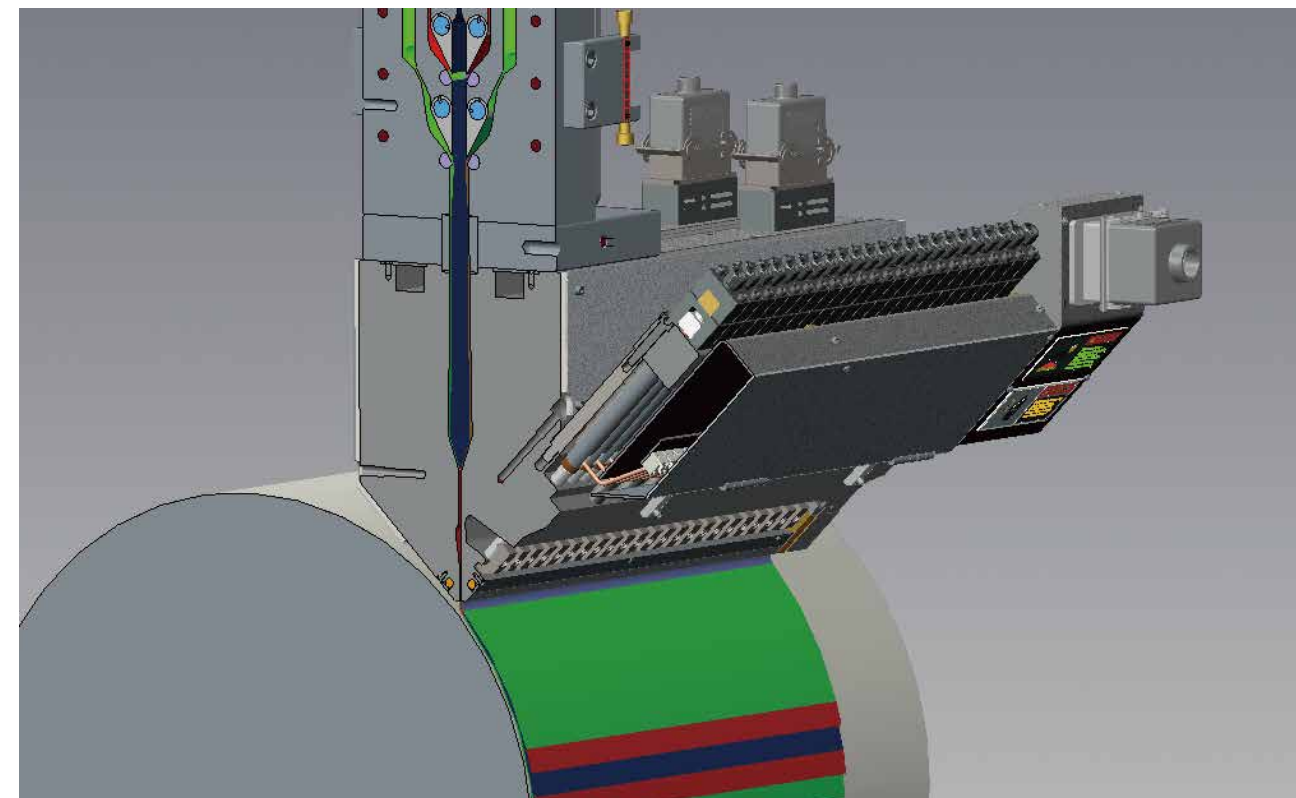

The die is crucial part of the biaxially oriented cast sheet, directly decided to cast sheet shape and thickness uniformity. This biaxially oriented casting sheet die adopt coat hanger flow channel design, and equip with professional computer fluid analysis software, Flow channel CFD analysis and optimization, to obtain the best fluid parameters. Die openings adjustment adopts the push-pull type automatic die lip adjustment, through online thickness gauge of the thickness of the detected data through computer program processing after feedback to the special die lip thermal expansion regulating bolts, for the opening of the die lip thickness automatic fine-tuning, effective control of product precision. This die applicable for: BOPP, BOPS, BOPA, BOPET, BOPI products etc.

The die lip straightness, roughness and the size of the lip sharp angle is direct impact on the quality of products. After experiments and repeated demonstration, using short-wave pulse local hardening treatment can be effective in improving the quality of the die. so that hardened surface hardness, microstructure refinement, wear resistance superior to conventional quenching process. The die lip straightness and abrasion resistance is better.



Die Used For Precision Slot Coating Field

精密狭缝涂布领域用模头

狭缝涂布模头应用领域/Applications

狭缝涂布模头可以生产出非常薄的涂层以及透明的光学涂层，同时可使涂层量保持在非常精确公差范围内，与将涂布液擦拭到基材上的涂布系统不同，我们的狭缝涂布模头属于模唇缝隙相对较大（可达到0.0762mm）的涂布模头，由此模唇缝隙抽吸出的液体可形成最薄至1 μm的涂层。狭缝涂布模头可在涂层厚度只有0.002mm或者是2 μm的情况下，将整个宽度上的涂层量控制在5%左右的公差变化范围内。我们生产的狭缝涂布模头模唇是固定的，因此可以利用可换的控隙片来改变涂层的厚度和宽度。涂布量从不足1 μm到254 μm的涂层厚度，该类模头可加工各种类型的胶粘剂（包括特殊的透明胶粘剂）电池、陶瓷电容器、装饰表面、电子显示介质、过滤膜、地板、燃料电池、磁性泥浆、医疗产品、光阻材料、压敏胶带、太阳能电池、超导体、撕带和窗用薄膜等。

Slot coating die can produce very thin and transparent optical coating layer. Meanwhile it can make the coating weight keep the very accurate tolerance range, it is different with the system which the coating fluid wiped on the base materials, our slot coating die is the die which die lip slot is relatively bigger(it can reach 0.0762mm). The coating fluid layer sucked from this die lip can be as thin as 1 μm. The slot coating die can control the coating weight tolerance in 5% in the whole width when the coating layer is only 0.002mm or 2 μm. The slot die lip we manufacture is fixed so that it can control the coating layer thickness and width by using the replaceable shims. The coating layer thickness can be from less than 1 μm to 254 μm. This kind of slot die can make different kinds of adhesive (include the special transparent adhesive) battery, ceramic capacitor, decorate surface, Electronic display medium, filtering film, floor board, fuel battery, Magnetic mud, medical product, photoresist, pressure sensitive tape, solar battery, superconductor, tear tape and film which used in the window.

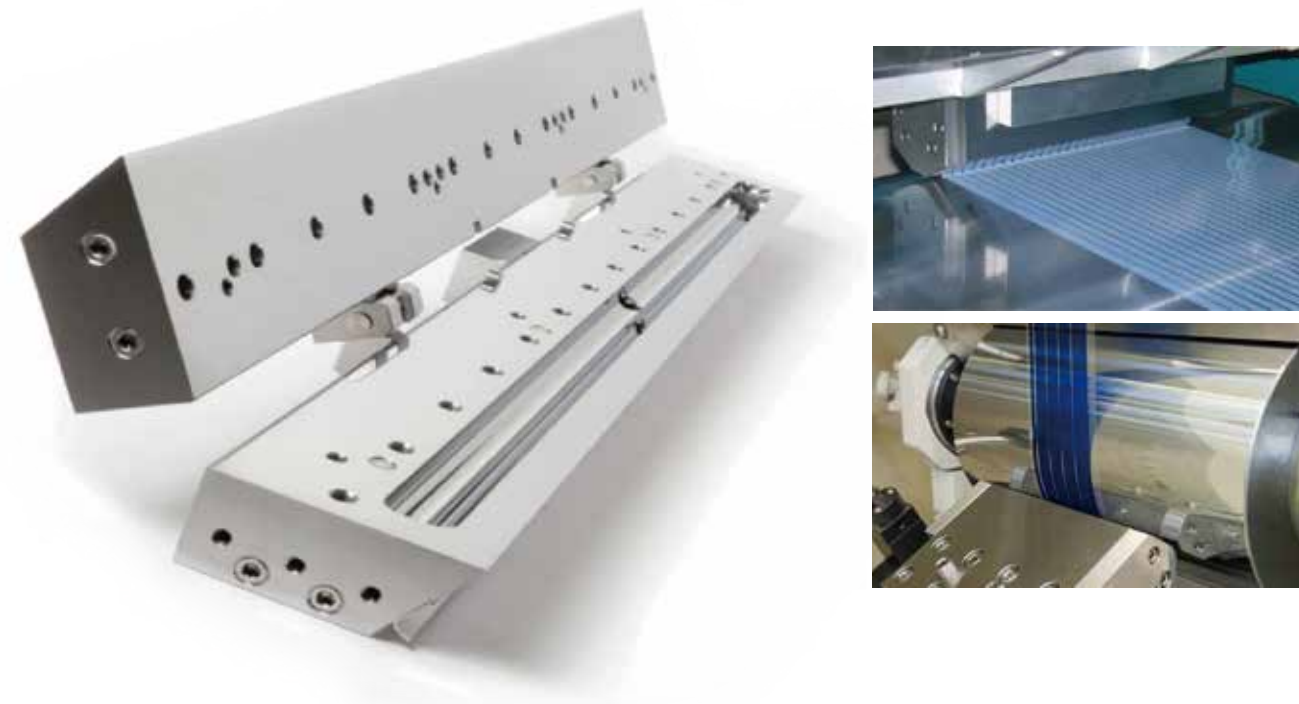

平模头修复升级改造 — 金纬,你的最佳合作伙伴

Extrusion Die Repair Upgraded — JWELL, Your Best Partner

作为挤出平模头专业制造商，我们将为您提供一整套模头清洗、检测、修复、升级、改造等标准服务。

经过JWELL翻新过的模头各项技术指标可以达到或非常接近初始标准。对于非JWELL原产的模头我们同样可以达到该要求。

针对每一套翻新模头我们都将严格按照以下步骤进行:

- | | |
|-----------------------|------------|
| 1、模头拆卸、清理 | 6、修复模体接合面 |
| 2、检查、评估，针对技术翻新要求与客户沟通 | 7、流道进行重新抛光 |
| 3、退除原始镀层 | 8、重新组装模头 |
| 4、修复受损表面或更改缺陷设计 | 9、校对各项技术指标 |
| 5、更换损坏部件 | |

我们为您提供的将是一整套专业流程式作业，服务范围涵盖一般维护到完全翻新。

As China's biggest extrusion equipment manufacturers, we will provide you a whole set standard services with die clean, examination, repair, upgrade, renovate and so on.

Renovates the die each technical specification after JWELL can achieve or very close to the initial standard, we may meet this requirements similarly regarding the non-JWELL production's die.

Every need to repair the die we will strictly according to the following steps:

- 1、The die remove, cleaning
- 2、Inspection, evaluation, and communicate with customer requirements for renovation
- 3、Faded except the original chromium plating
- 4、Repair damaged surface defects or change the defects in design
- 5、Replace damaged parts
- 6、Repairing mold body joints
- 7、The mold flow channel to polish
- 8、Reassemble the die
- 9、Proofreading technical specification





We provide for you will be a whole set specialized flow type work, the range of service covering general maintenance and completely renovated.



品质管理 技术研发 国际交流 客户服务 员工培训

QUALITY CONTROL TECHNOLOGY RESEARCH INTERNATIONAL COMMUNICATION CUSTOMER SERVICE STAFF TRAINING



 <p>24小时服务 24 Hours Service</p>	 <p>86-573 87786088 客户服务热线 Customer Service Hotline</p>	 <p>培 训 Training</p>	 <p>交钥匙工程 Turn-Key Project</p>
--	--	---	---